

VK-BFP-106G



6" PVC Butterfly Valve

EPDM Seat, Gear Operated

PVC wafer style butterfly valve with EPDM seat.

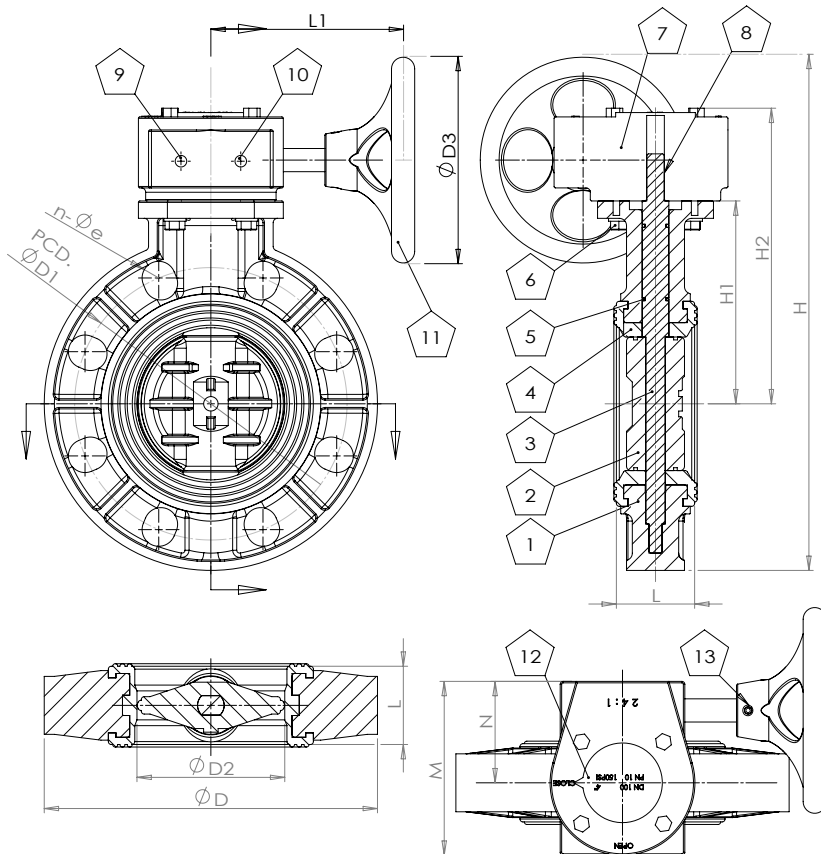

Size	6"
Body Material	PVC
Body Design	Wafer
Operation	Gearbox
Connections	Flange / ANSI 125
Pressure Rating	150 PSI
Weight	23 lbs

Features

- Gearbox operator is self-locking in any position for throttle control
- Excellent corrosion resistance
- Does not require flange gaskets thanks to EPDM seat

Materials List

No.	Part Name	Material	No.	Part Name	Material
1	Body	CPVC	9	Open Adjust	
2	Disc	CPVC	10	Close Adjust	
3	Stem	304 SST	11	Hand Wheel	Cast Iron
4	Seat	EPDM	12	Indicator	304 SST
5	O-Ring	EPDM	13	Pin	Steel
6	Bolt	304 SST			
7	Gearbox	Cast Iron			
8	Key	Steel			

Dimensions

Size	DN	ØD		L		P.C.D. ØD1		n-Øe		ØD2		H		H1		H2		L1		ØD3		M		N	
in.		in.	mm	in.	mm	in.	mm	in.	mm	in.	mm	in.	mm	in.	mm	in.	mm	in.	mm	in.	mm	in.	mm	in.	mm
6"	150	11.3	288	2.8	70	9.5	241	8-Ø23	5.8	146	19.3	489	7.1	180	9.8	250	7.9	200	10.3	260	5.9	150	3.6	90	
8"	200	13.6	344	3.4	88	11.8	298	8-Ø23	7.8	199	21.8	552	8.4	215	11.3	285	7.9	200	10.3	260	5.9	150	3.6	90	
10"	250	16.3	412	3.9	98	14.3	362	12-Ø23	9.7	246	25.4	646	10.3	260	13.4	340	8.7	220	11	280	7.1	180	4.8	120	