

## 4" Cast Iron Butterfly Valve | Lug Style EPDM Seat, Lever Operated

Cast iron lug style butterfly valve with nickel plated ductile iron disc and EPDM seat.

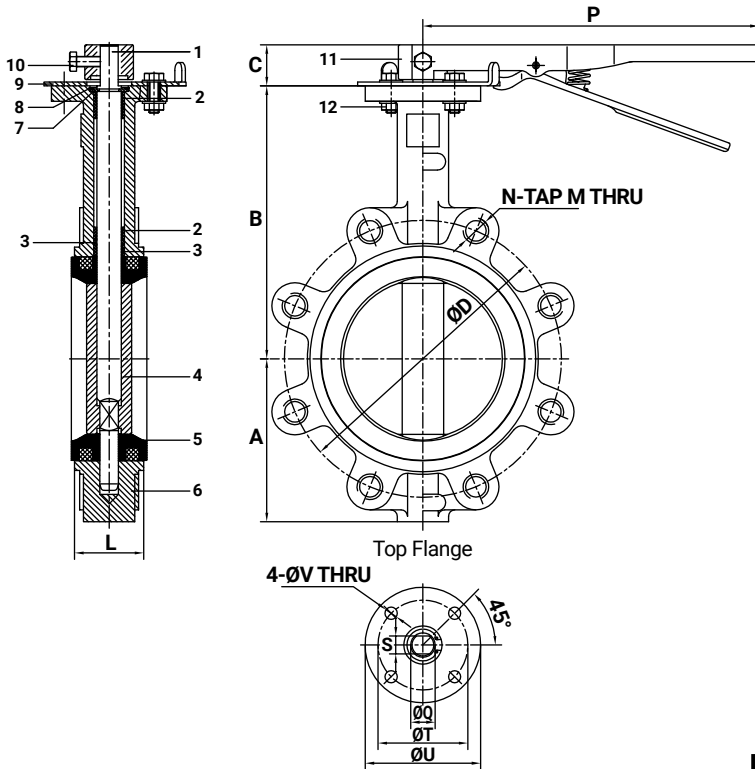

<b>Size</b>	4"
<b>Body Material</b>	Cast Iron
<b>Body Design</b>	Lug Type
<b>Operation</b>	Lever
<b>Connections</b>	Flange / ANSI 125
<b>Pressure Rating</b>	150 PSI
<b>Length (End to End)</b>	2"
<b>Weight</b>	16 lbs

### Features

- Lever handle can lock in 10 positions for throttle control
- Fusion-Bonded Epoxy Coating
- Does not require flange gaskets thanks to EPDM seat

### Materials List

No.	Part Name	Material	No.	Part Name	Material
1	Stem	SS416	7	Thrust Washer	Carbon Steel
2	Bushing	PTFE	8	Circlip	Carbon Steel
3	O-Ring	EPDM	9	Locking Plate	SS420
4	Disc	Ductile Iron	10	Locking Screw	Stainless Steel
5	Seat	EPDM	11	Lever	Malleable CI
6	Body	Cast Iron	12	Bolt & Nut	Stainless Steel

### Dimensions

Size	A		B		C		Class150			L		P		ØQ		S		ØT		ØU		ØV		
	in.	mm	in.	mm	in.	mm	ØD (in./mm)	M	N	in.	mm	in.	mm	in.	mm	in.	mm	in.	mm	in.	mm	in.	mm	
2"	3	76	6 <sup>5</sup> / <sub>8</sub>	162	1 <sup>1</sup> / <sub>4</sub>	32	4 <sup>3</sup> / <sub>4</sub>	120.7	5/8"-11 UNC	4	1 <sup>1</sup> / <sub>8</sub>	42	10 <sup>1</sup> / <sub>16</sub>	255	1/2	12.7	3/8	10	2 <sup>3</sup> / <sub>4</sub>	70	3 <sup>3</sup> / <sub>16</sub>	90	3/8	9.5
3"	3 <sup>3</sup> / <sub>4</sub>	95	7 <sup>1</sup> / <sub>8</sub>	181	1 <sup>1</sup> / <sub>4</sub>	32	6	152.4	5/8"-11 UNC	4	1 <sup>1</sup> / <sub>4</sub>	45	10 <sup>1</sup> / <sub>16</sub>	255	1/2	12.7	3/8	10	2 <sup>3</sup> / <sub>4</sub>	70	3 <sup>3</sup> / <sub>16</sub>	90	3/8	9.5
4"	4 <sup>1</sup> / <sub>2</sub>	114	7 <sup>7</sup> / <sub>8</sub>	200	1 <sup>1</sup> / <sub>4</sub>	32	7 <sup>1</sup> / <sub>2</sub>	190.5	5/8"-11 UNC	8	2 <sup>1</sup> / <sub>16</sub>	52	10 <sup>1</sup> / <sub>16</sub>	255	3/8	15.88	1/2	12	2 <sup>3</sup> / <sub>4</sub>	70	3 <sup>3</sup> / <sub>16</sub>	90	3/8	9.5
6"	5 <sup>1</sup> / <sub>2</sub>	139	8 <sup>7</sup> / <sub>8</sub>	225	1 <sup>1</sup> / <sub>4</sub>	32	9 <sup>1</sup> / <sub>2</sub>	241.3	3/4"-10 UNC	8	2 <sup>1</sup> / <sub>16</sub>	56	10 <sup>1</sup> / <sub>16</sub>	255	3/4	19.05	9/16	14	2 <sup>3</sup> / <sub>4</sub>	70	3 <sup>3</sup> / <sub>16</sub>	90	3/8	9.5
8"	6 <sup>15</sup> / <sub>16</sub>	177	10 <sup>1</sup> / <sub>4</sub>	260	1 <sup>1</sup> / <sub>2</sub>	38	11 <sup>1</sup> / <sub>4</sub>	298.5	3/4"-10 UNC	8	2 <sup>1</sup> / <sub>8</sub>	60	14	355	7/8	22.23	1 <sup>1</sup> / <sub>16</sub>	17	4	102	4 <sup>15</sup> / <sub>16</sub>	125	7/16	11.5
10"	8	203	11 <sup>1</sup> / <sub>2</sub>	292	1 <sup>1</sup> / <sub>2</sub>	38	14 <sup>1</sup> / <sub>4</sub>	362	7/8"-9 UNC	12	2 <sup>1</sup> / <sub>8</sub>	66	14	355	1 <sup>1</sup> / <sub>8</sub>	28.58	7/8	22	4	102	4 <sup>15</sup> / <sub>16</sub>	125	7/16	11.5
12"	9 <sup>1</sup> / <sub>2</sub>	242	13 <sup>1</sup> / <sub>4</sub>	337	1 <sup>1</sup> / <sub>2</sub>	38	17	431.8	7/8"-9 UNC	12	3 <sup>1</sup> / <sub>16</sub>	77	14	355	1 <sup>1</sup> / <sub>4</sub>	31.75	1 <sup>1</sup> / <sub>16</sub>	24	4	102	4 <sup>15</sup> / <sub>16</sub>	125	7/16	11.5