

3" PVC Butterfly Valve | Wafer

Stainless Steel Disc, EPDM Seat, Lever Operated

PVC wafer style butterfly valve with stainless steel disc and EPDM seat.

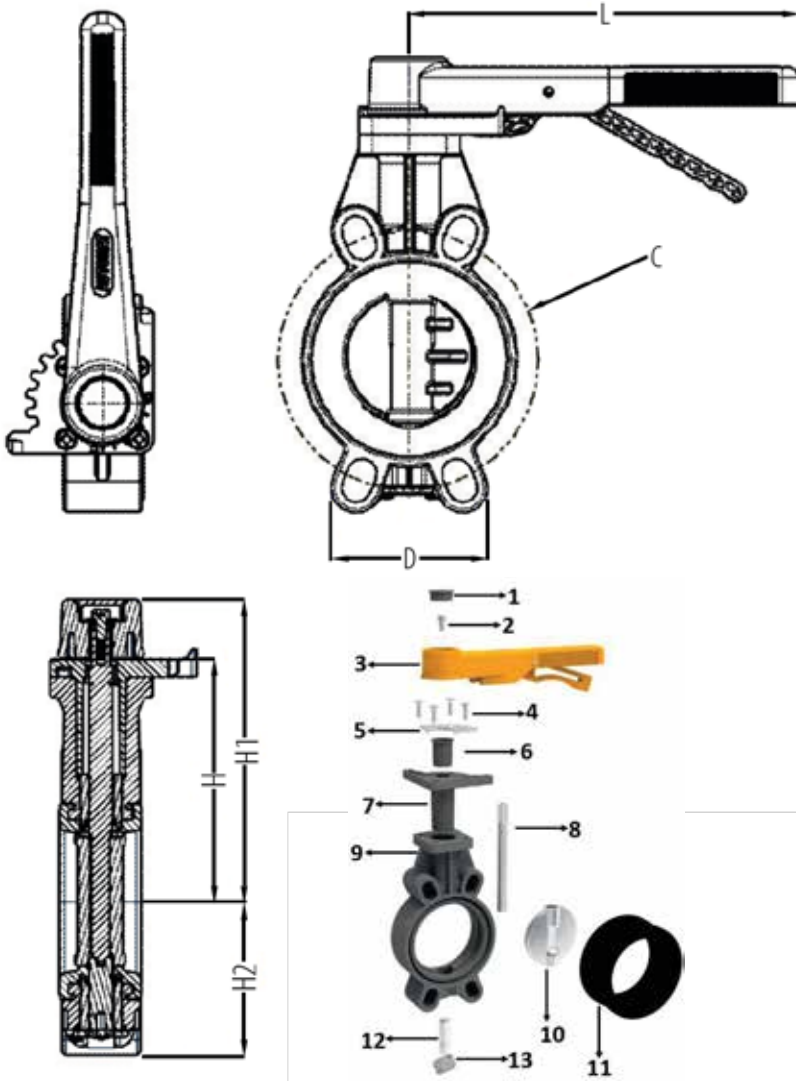

Size	3"
Body Material	PVC
Body Design	Wafer
Operation	Lever
Connections	Flange / ANSI 125
Pressure Rating	145 PSI
Length (End to End)	1.8125"
Weight	lbs

Features

- Lever handle can lock in 10 positions for throttle control
- Fusion-Bonded Epoxy Coating
- Does not require flange gaskets thanks to EPDM seat

Materials List

No.	Part Name	No.	Part Name
1	Cap	8	Shaft
2	Allen Screw	9	Body
3	Handle	10	Disc
4	Screw	11	Seal
5	Clutch Plate	12	Small Shaft
6	Bushing	13	Base Plate
7	Sleeve		

Dimensions

Size	D		H1		H2		H		L		C (PCD)	
in.	in.	mm	in.	mm	in.	mm	in.	mm	in.	mm	in.	mm
2"	4 ³⁹ / ₆₄	117	5 ⁸ / ₁₆	130	2 ⁵¹ / ₆₄	71	6 ¹ / ₂	165	9 ¹ / ₆₄	229	4 ⁴⁹ / ₆₄	121
3"	5 ³ / ₆₄	128	5 ⁴³ / ₆₄	144	3 ³⁷ / ₆₄	91	7 ³ / ₃₂	180	9 ¹ / ₆₄	229	6 ³ / ₆₄	156