

3" Double Union PVC Ball Valve

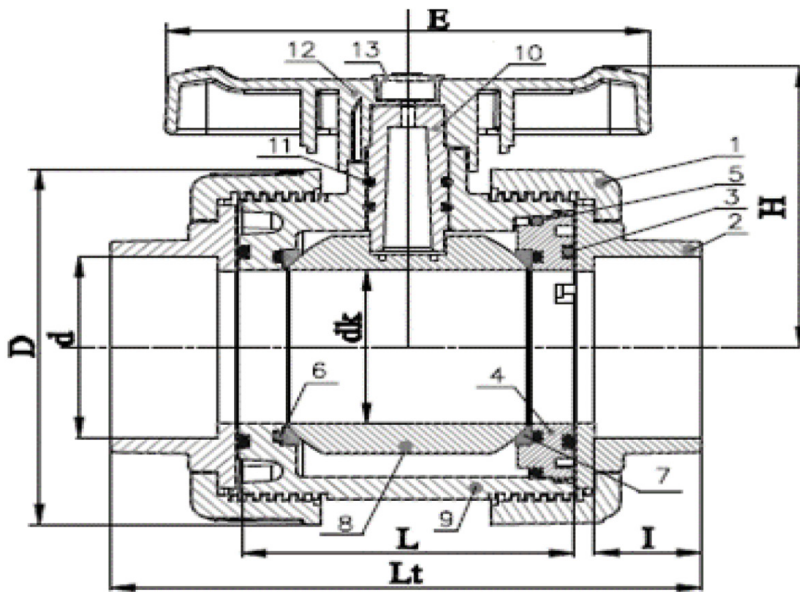

Size	3"
Body Material	PVC
Connections	Slip/Weld
Pressure Rating	145 PSI
Weight	7.61 lb

Features

- Quarter-turn handle operated ball valve
- TPE seals with O-ring gives cushioning effect that ensures leakage free and low fixed torque
- Union nut load does not transfer onto ball
- Chemical and corrosion resistant, color UV stabilized

Dimensions

Size	ASTM (d)		dk		D		I		L		Lt		E		H	
in.	in.	mm	in.	mm	in.	mm	in.	mm	in.	mm	in.	mm	in.	mm	in.	mm
1"	1.32	33.4	1	25	2.7	69	0.8	20	2.2	56	4.3	110	2.8	71	2.6	67
1-1/2"	1.9	48.26	1.6	40	3.7	94	1.3	32	2.9	73	5.9	150	4.8	121	3.4	88
2"	2.38	60.33	1.9	50	4.6	116	1.4	35	3.3	84	6.9	177	5.9	150	3.8	97
3"	3.5	88.9	3	76	7.4	189	1.7	43	5.4	138	9.5	241	7.9	200	5.5	140

Materials List

No.	Part Name	Material
1	Ring	UPVC
2	Socket	UPVC
3	Bush Small O-Ring	HNBR
4	Bush	UPVC
5	Bush Big O-Ring	HNBR
6	Seal Washer*	HNBR
7	Seal	EPDM/TPE
8	Ball	UPVC
9	Body	UPVC
10	Shaft	UPVC
11	Shaft O-Ring	HNBR
12	Handle	ABS
13	Handle Logo	ABS