

3" Cast Iron Pressure Reducing Valve Flanged

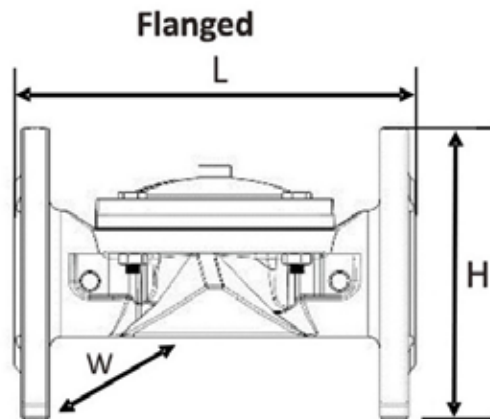

Size	3"
Connection	Flanged
Max Flow	140 GPM
Max Working Pressure	232 PSI
Minimum Pressure	8 PSI

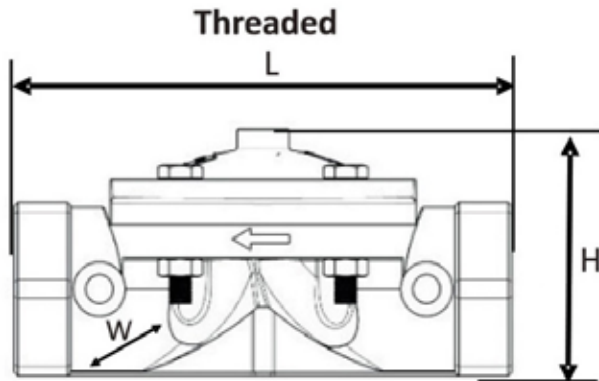
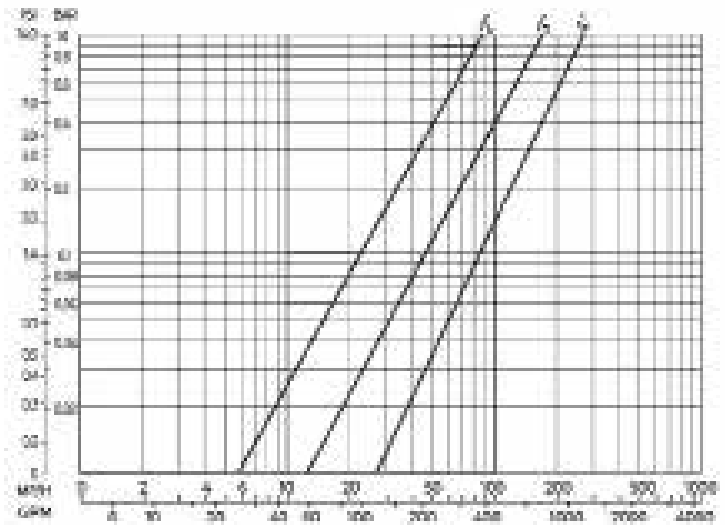

Dimensions

Size	H		W		L	
	in.	mm	in.	mm	in.	mm
2"	3.88	99	5.75	145	8.25	210
3"	7.88	199	7.88	199	10.62	270
4"	8.62	220	10.13	258	13.75	350